



Table de kinésithérapie-ostéopathie
Gamme ECOMAX
ECOMAXKINE700

CARINA
Medical



CE
ISO 9001
ISO 13485

DESCRIPTION TECHNIQUE

- Table de kinésithérapie-ostéopathie, 2 plans
- Réglage de la tête en toutes positions par vérin à gaz
- Sellerie tendue plate de bonne densité 24kg/cm², non-feu classée M2, épaisseur 6cm
- Equipé d'un porte-rouleau pour drap d'examen : possibilité de le fixer côté pied ou côté tête
- Ensemble totalement soudé : très grande solidité
- Piètement acier peint époxy, coloris argent

DIMENSIONS

- Largeur 70cm
- Hauteur 80cm
- Capacité de charge : 150kg

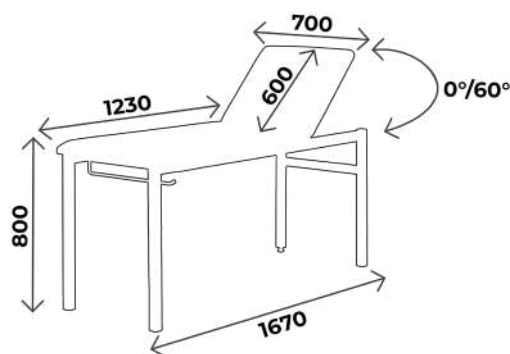

Vous aimerez aussi :

Réf. **ECOMAXKINE600** :

Idem ECOMAXKINE700 mais largeur 60cm



À SAVOIR

- ✓ Délai : 15 jours à réception commande
- ✓ Garantie : 2 ans (1 an pour la sellerie)

LES COUSSINS

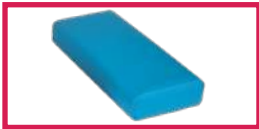

COUSSIN-001
Coussin rectangulaire, mousse HR
dim. 440x200x75mm



COUSSIN-002
Coussin 1/2 cylindrique,
mousse HR dim. 450x120mm,
rayon 120mm



COUSSIN-003
Coussin cylindrique, mousse HR
dim. 440x200x75mm

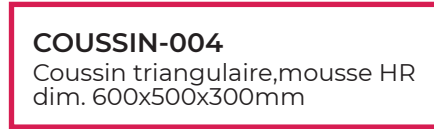

COUSSIN-004
Coussin triangulaire, mousse HR
dim. 600x500x300mm

COLORIS SELLERIE

Sellerie non-feu
classée M2

Pour les coloris de sellerie, vous avez le choix entre la gamme ECOMAX, Classique et Urban
Attention ! coloris Classique et Urban **avec plus value**

Revêtement : Sellerie Gamme ECOMAX*



Galapagos



Bahamas

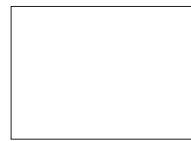

Blanc



Tahiti



Malouines

*Coloris standards pour gamme ECOMAX et SIMPLEX,
coloris Classique et Urban disponibles **sur demande**



COLORIS SELLERIE

Sellerie non-feu
classée M1

Pour les coloris de sellerie, vous avez le choix entre la gamme Classique et Urban
Attention ! coloris Classique et Urban **avec plus value**

Revêtement : Sellerie Gamme Classique



Arno



Garonne



Potomac

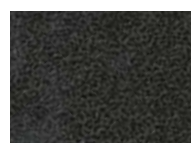

Amour



Mississippi

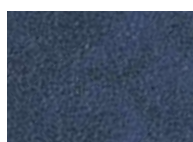

St Laurent



Rhône



Missouri



Seine



Amazone

Revêtement : Sellerie Gamme Urban



Abysse

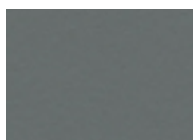

Cendre



Origan

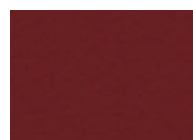

Géranium



Réglisse



Prune

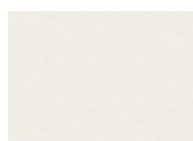

Perle

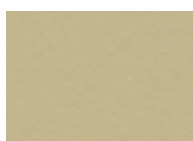

Ficelle

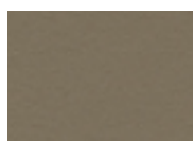

Terre

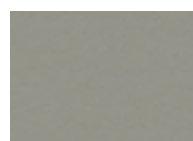

Béton



Chataigne

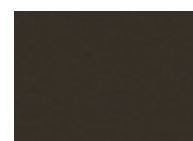

Chocolat

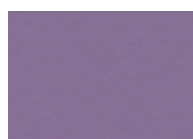

Pensée



Pétrole



Turquoise



Granny



Absinthe



Ananas



Orange



Fuschia



Tomate



GUIDE D'ENTRETIEN

ENTRETIEN QUOTIDIEN

- Sellerie : nettoyage à l'eau savonneuse uniquement (solvants proscrits), peut être désinfecté avec des produits tels que Phagosept Spray, Salvanios pH10 à 0,75% et Anios Surfaces Hautes, sans matière abrasive
- Piètement : nettoyage à l'eau savonneuse uniquement (solvants proscrits) sans matière abrasive

GARANTIE

- Châssis : 2 ans
- Sellerie : 1 an



CONTACT

CARINA
Médical

Parc d'entreprises Visionis
278 rue de l'industrie
01090 GUÉREINS- FRANCE

SERVICE COMMERCIAL

Tél : +33(0)4 74 66 69 49
Fax : +33(0)4 74 66 69 50
commercial@carinamedical.com